

# Vool, pinge, Ohmi seadus

$$I = U/R$$

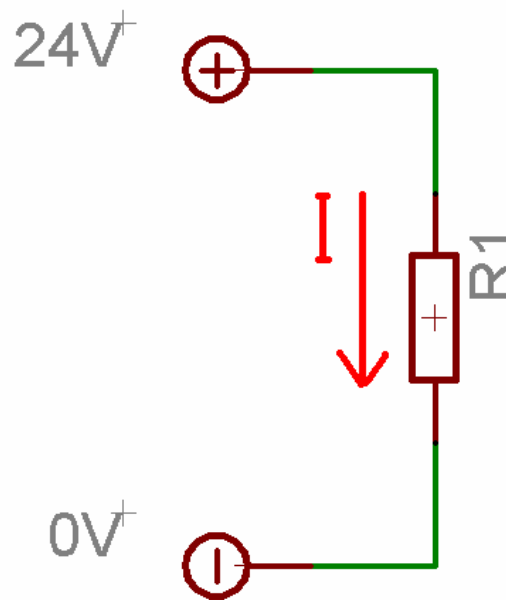

# Pingeregulaator

ing k *fixed voltage regulator*

TO-220 Power Package (T)

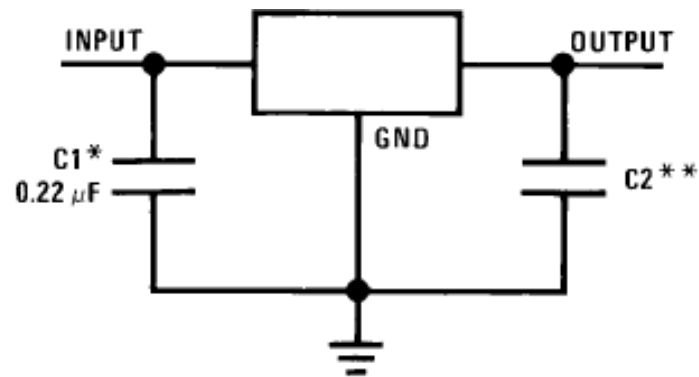
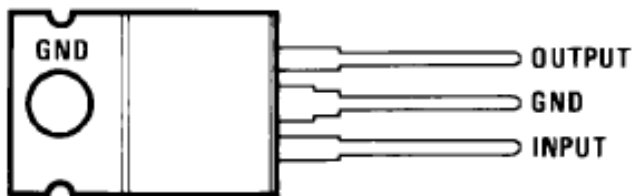

# Kondenssaator ing k - *capacitor*

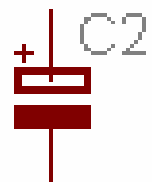
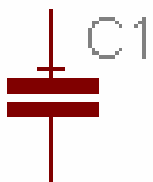

$$X_c = \frac{1}{2\pi f C}$$

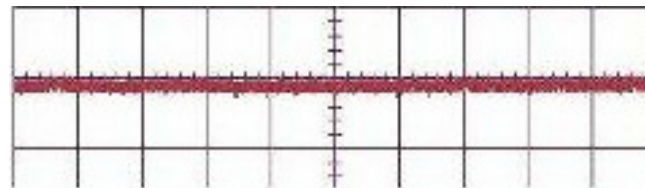
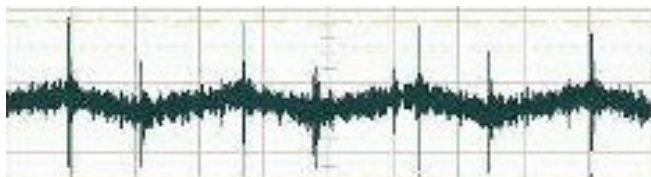

# Valgusdiood ing k *LED – Light Emitting Diode*

$$R1 = (5 - V_f) * I$$

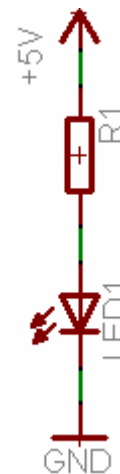

# Fototransistor

ing k – *photo transistor*

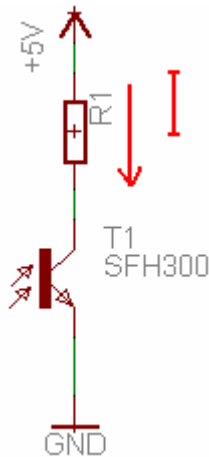

$$I_{\max} = 50\text{mA}$$

$$R1 > U / I_{\max} \Rightarrow R1 > 5 / 0,05$$

$$R1 > 100\Omega$$



# Induktiivsus juhtmetes

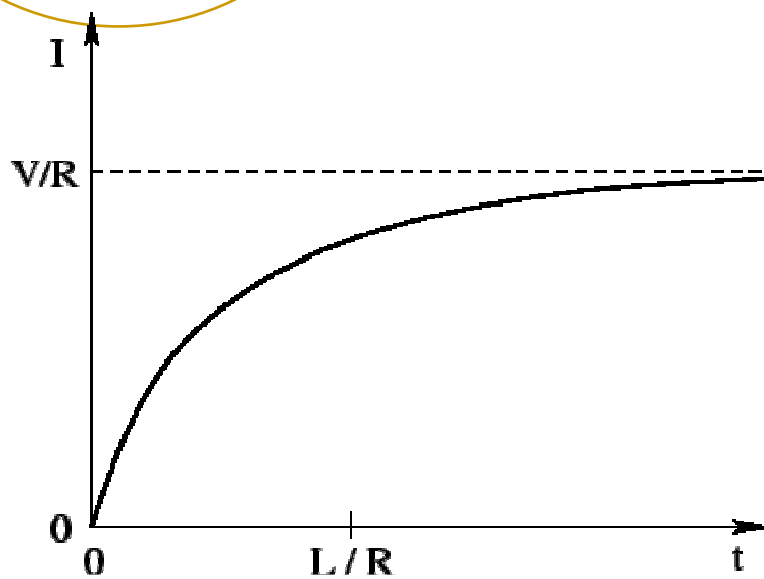



# Pliiaku

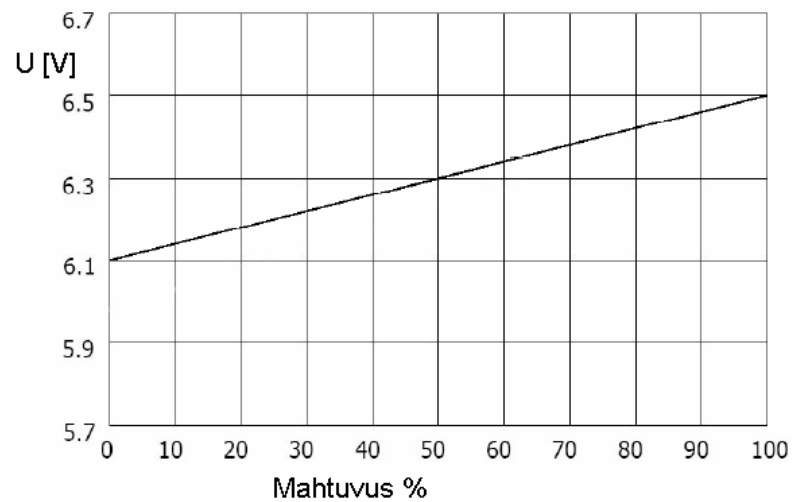

- +Odav
- +töökindel
- suur ja raske



# Transistor

ing k *transistor*

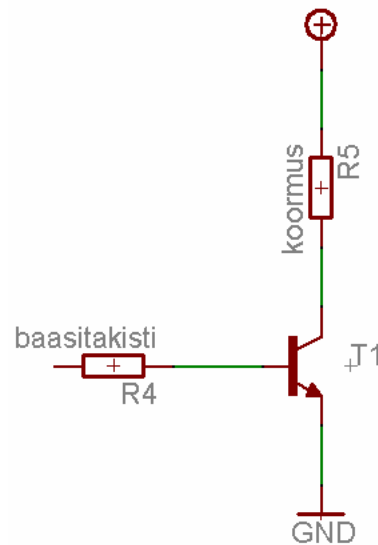

Võimendi  
Lüliti





# Diod ing k *diode*

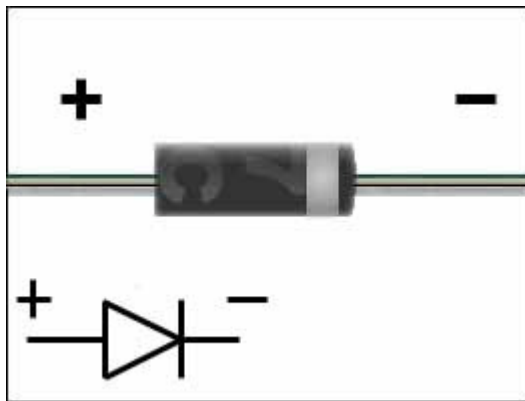

Juhib voolu ühes suunas

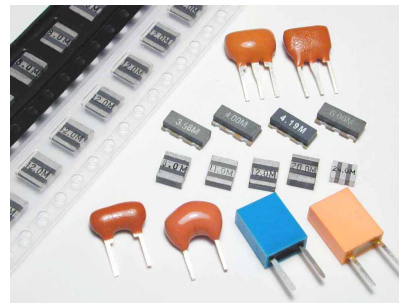

# Resonaator ing k *resonator*

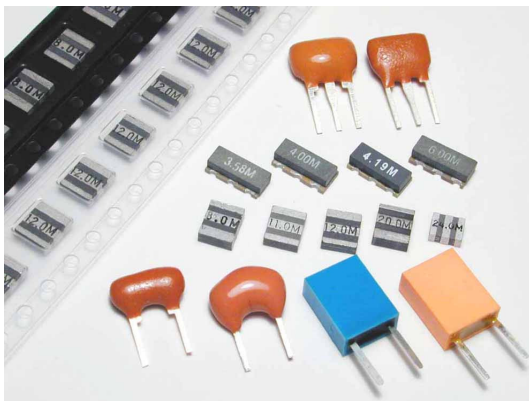

Taktsageduse  
genereerimiseks

